

Article number: 20343260M24138KR
Description: E+G Levelling foot
GN 343.2-60-M24-138-KR
Note: 0

Measures

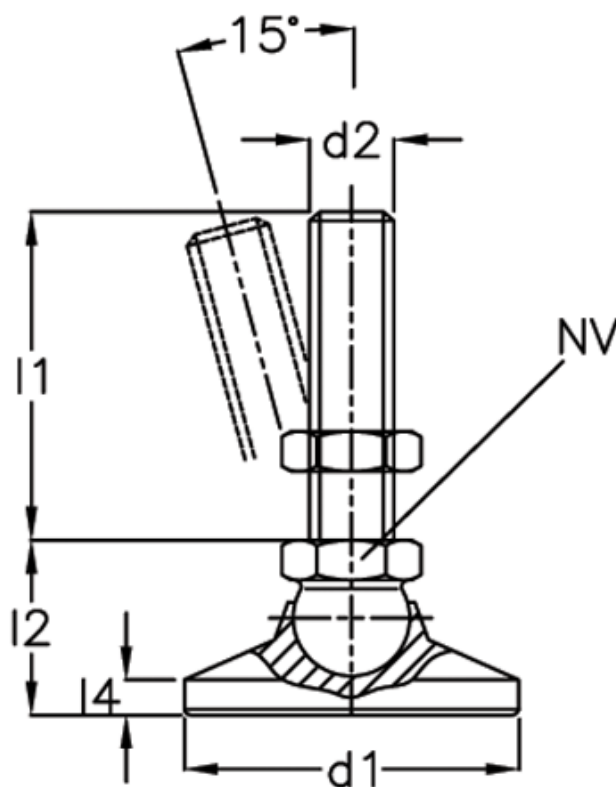

d1 = 60
d2 = M24
l1 = 138
l2 = -
l3 = 37.5
l4 = -
l5 = 10
NV = 24

Static load = 30
Weight in (g) = 630